

PowerCool Series Thermoelectric Cooler Assembly

The DA-044-24-02 is a Direct-to-Air Thermoelectric Cooler Assembly that uses impingement flow to transfer heat. It offers dependable, compact performance by cooling objects via conduction. Heat is absorbed through a cold plate and dissipated thru a high density heat exchanger equipped with an air ducted shroud and brand name fan. It has a maximum Q_c of 44 Watts when $\Delta T = 0$ and a maximum ΔT of 41 °C at $Q_c = 0$.

Features

- Compact design
- Precise temperature control
- Reliable solid-state operation
- Low noise
- RoHS-compliant

Applications

- Medical Diagnostic and Analytical Instrumentation
- Thermoelectric Coolers and Assemblies for Medical Applications
- Liquid Cooling Options for PET and SPECT Scanners
- Cooling for Centrifuges
- High-Performance Liquid Chromatography (HPLC)
- Heating and Cooling for Liquid Chromatography Systems

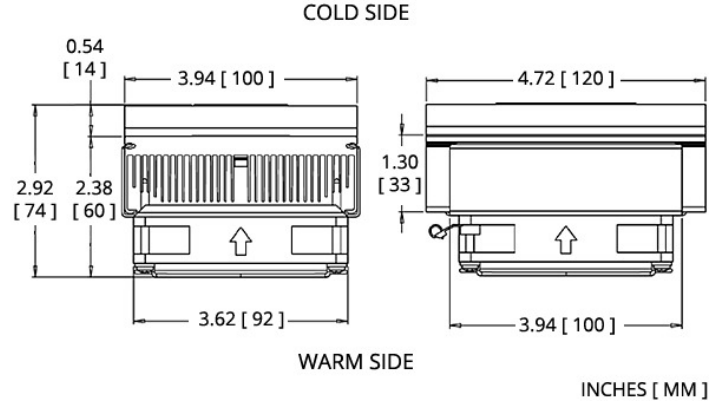

ELECTRICAL AND THERMAL PERFORMANCE

Heat Pumped at Cold Side (Q_c)
 Tambient = 35°C

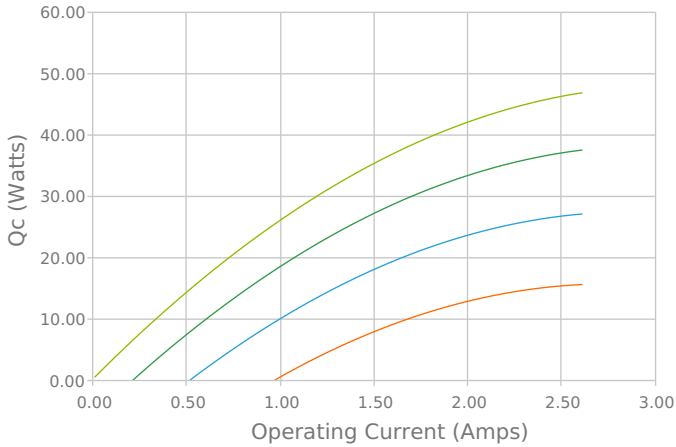

Heat Pumped at Cold Side (Q_c)
 Tambient = 35°C

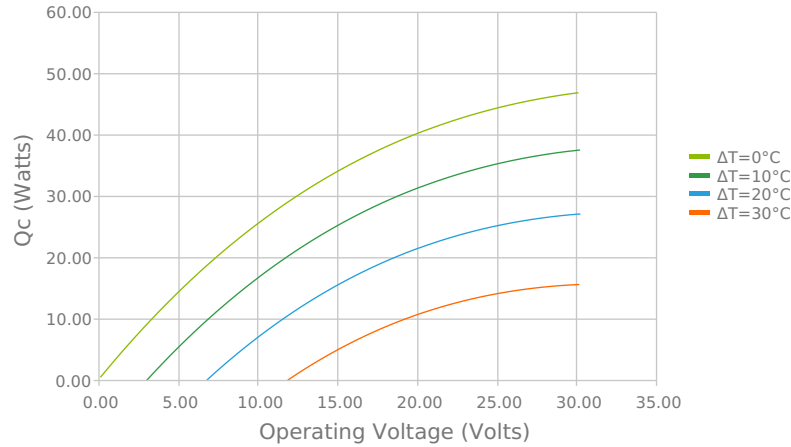

Coefficient of Performance (COP = Qc/Pin)
 Tambient = 35°C

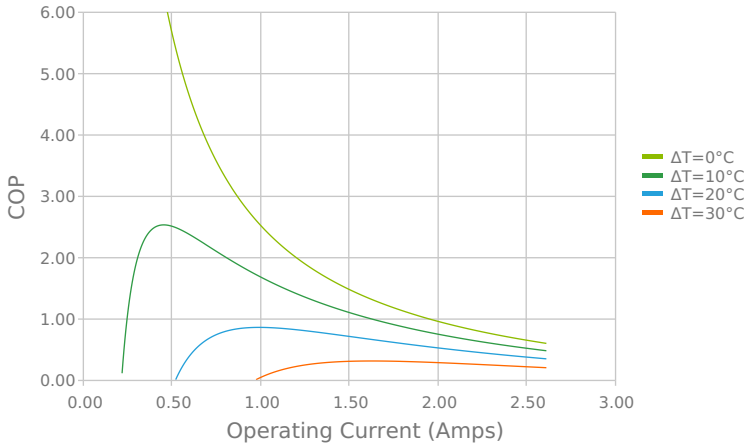

Coefficient of Performance (COP = Qc/Pin)
 Tambient = 35°C

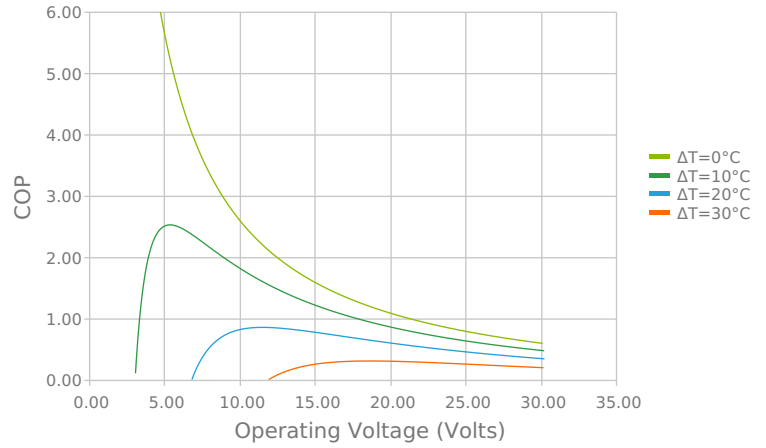

Total Heat Dissipated at Hot Side (Qh=Qc+Pin)
 Tambient = 35°C

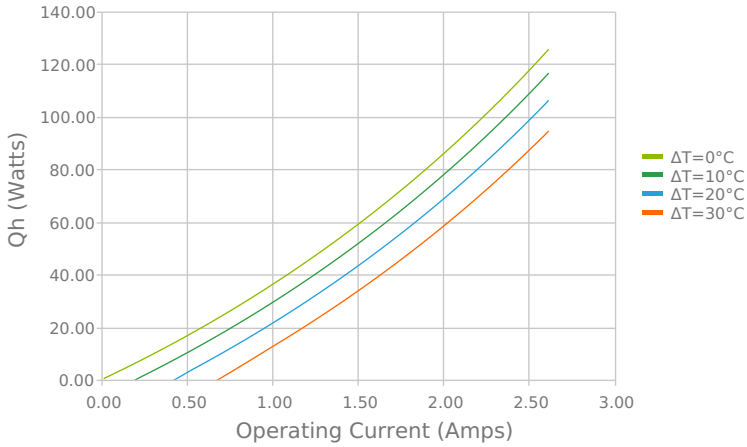

Total Heat Dissipated at Hot Side (Qh=Qc+Pin)
 Tambient = 35°C

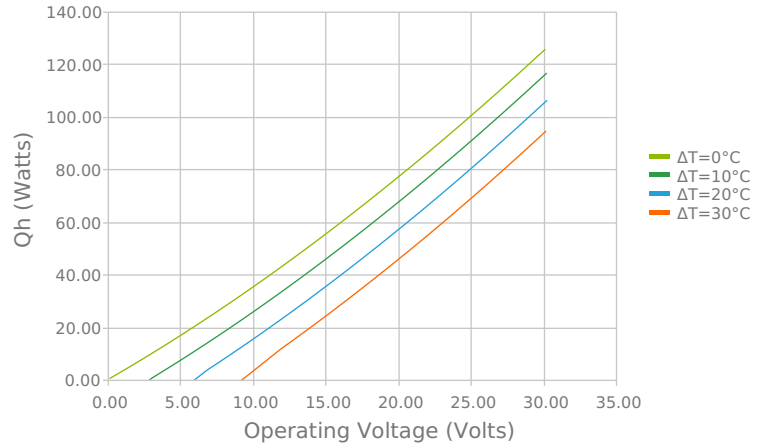

Heat Pumped at Cold Side (Qc)
 Voperating = 24 Volts | Ioperating = 2.16 Amps

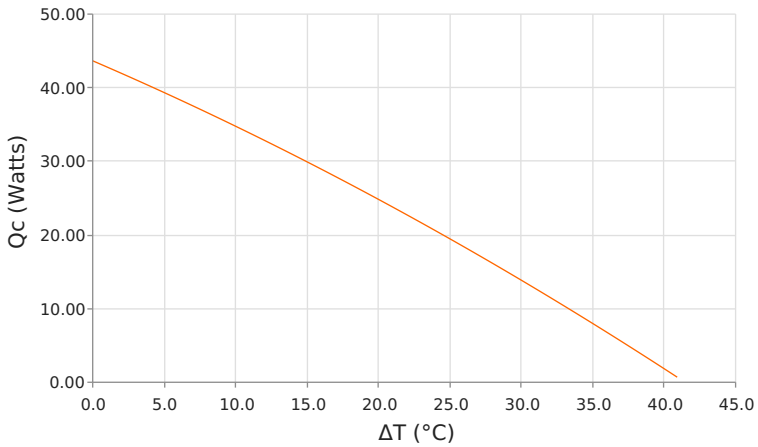

Coefficient of Performance (COP = Qc/Pin)
 Voperating = 24 Volts | Ioperating = 2.16 Amps

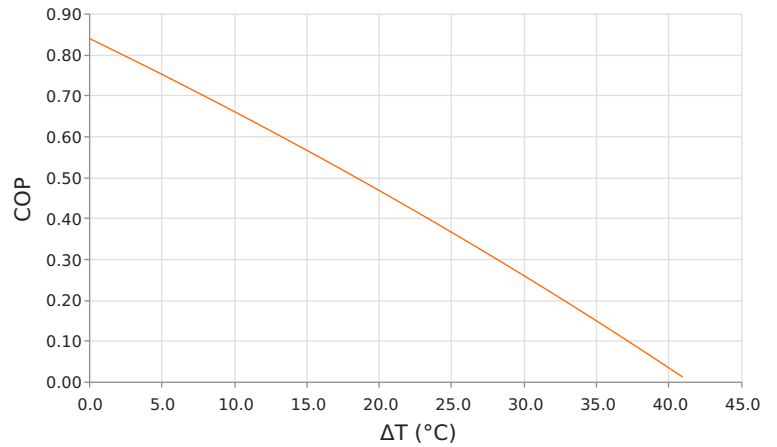

SPECIFICATIONS

Heat Transfer Mechanism, Cold Side

Heat Transfer Mechanism, Hot Side

Operating Temperature Range

Supply Voltage

Current Draw

Power Supply

Performance Tolerance

Hi-Pot Testing

Fan MTBF

Weight

Panel Mounting

Direct - Conduction
Air - Forced Convection
-10°C to 44°C
24.0 VDC nominal / 30.0 VDC maximum
2.2 A running / 2.8 A startup
46.0 Watts
10%
No Testing
50000 hours
0.60 kg
Flush Mount

MOUNTING HOLE LOCATION

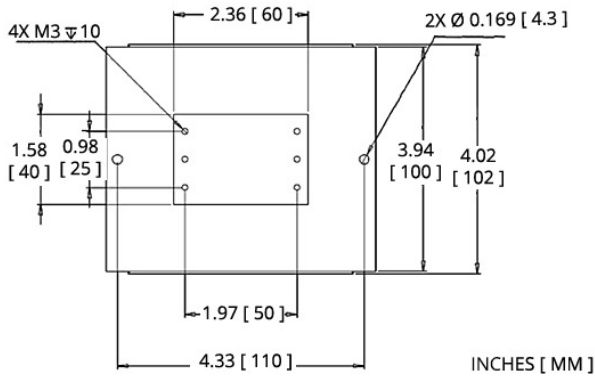

WIRING SCHEMATIC

ELECTRICAL CONNECTIONS:		
ITEM	Wire Color	Crimp Ferrule Color
TEM+	Red	White
TEM -	Black	White
FAN+	Red	Blue
FAN -	Black	Blue

NOTES

¹For indoor use only

²Units are generally maintenance free, however occasionally it is recommended to clean the heat sinks and fans of debris. This is best done with compressed air.

Any information furnished by Laird and its agents, whether in specifications, data sheets, product catalogues or otherwise, is believed to be (but is not warranted as being) accurate and reliable, is provided for information only and does not form part of any contract with Laird. All specifications are subject to change without notice. Laird assumes no responsibility and disclaims all liability for losses or damages resulting from use of or reliance on this information. All Laird products are sold subject to the Laird Terms and Conditions of sale (including Laird’s limited warranty) in effect from time to time, a copy of which will be furnished upon request.

© Copyright 2019-2024 Laird Thermal Systems, Inc. All rights reserved. Laird™, the Laird Ring Logo, and Laird Thermal Systems™ are trademarks or registered trademarks of Laird Limited or its subsidiaries.

Revision: 01 Date: 04-30-2024

Print Date: 04-30-2024