

Liquid Series Thermoelectric Cooler Assembly

The LA-024-24-02 thermoelectric assembly (TEA) offers dependable, compact performance by cooling objects via liquid to transfer heat. Heat is absorbed through a liquid heat exchanger and dissipated thru a high density heat sink equipped with an air ducted shroud and brand name fan. The thermoelectric modules are custom designed to achieve a high coefficient of performance (COP) to minimize power consumption. It has a maximum Q_c of 19 Watts when $\Delta T = 0$ and a maximum ΔT of 36 °C at $Q_c = 0$. The liquid heat exchanger is designed to accommodate distilled water with glycol. Corrosion resistant turbulators are enclosed inside channels to increase heat transfer. Mating port adaptors are sold separately.

Features

- Compact design
- Precise temperature control
- Reliable solid-state operation
- DC operation
- RoHS-compliant

Applications

- Medical Diagnostics
- Industrial Lasers
- Medical Lasers
- Analytical Instrumentation

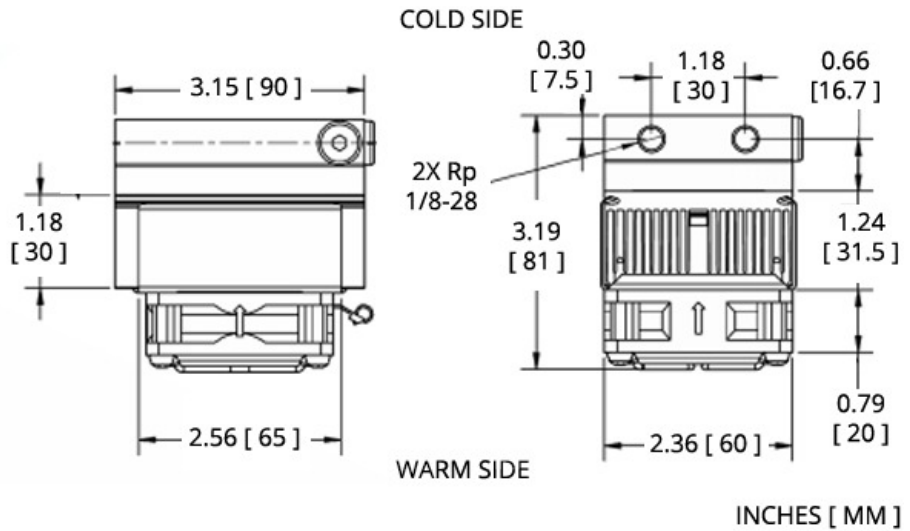

ELECTRICAL AND THERMAL PERFORMANCE

Heat Pumped at Cold Side (Q_c)
 Tambient = 35°C | Tcontrol = 20°C

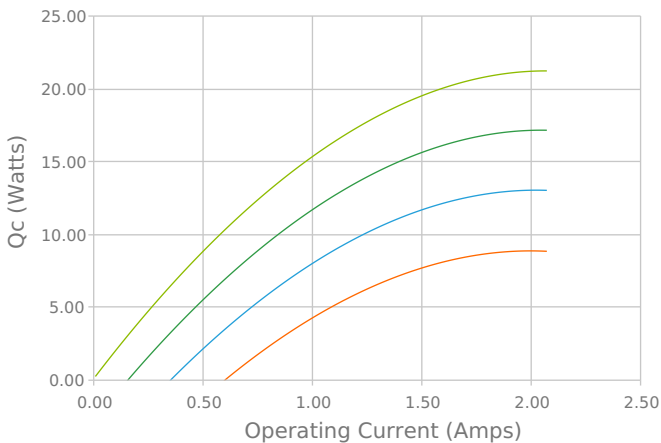

Heat Pumped at Cold Side (Q_c)
 Tambient = 35°C | Tcontrol = 20°C

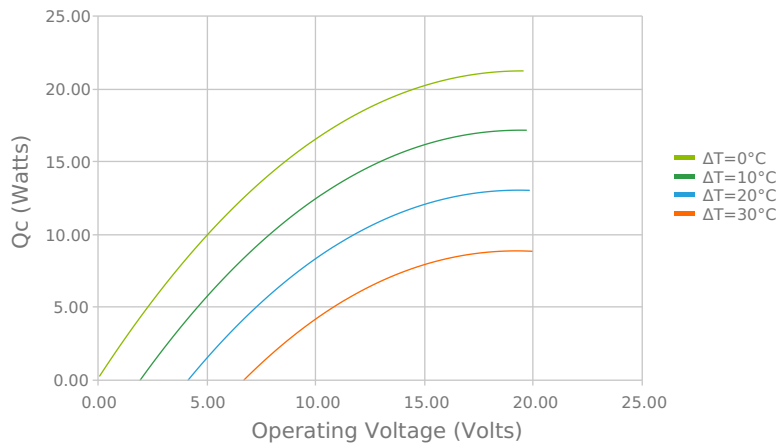

Coefficient of Performance (COP = Qc/Pin)
 Tambient = 35°C | Tcontrol = 20°C

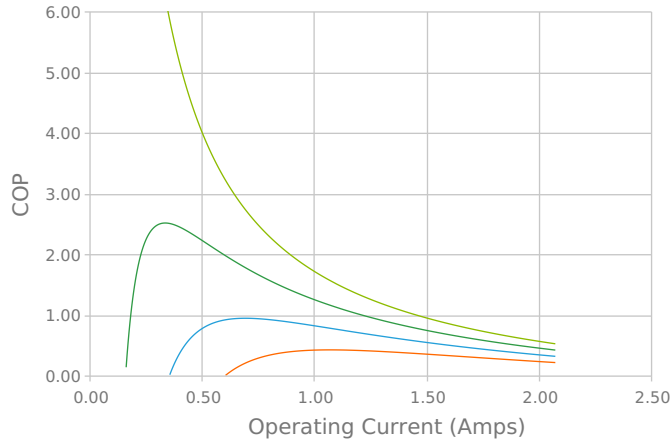

Coefficient of Performance (COP = Qc/Pin)
 Tambient = 35°C | Tcontrol = 20°C

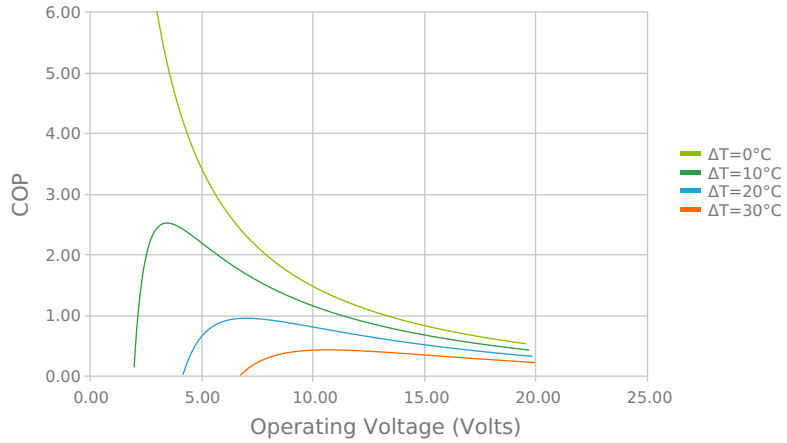

Total Heat Dissipated at Hot Side (Qh=Qc+Pin)
 Tambient = 35°C | Tcontrol = 20°C

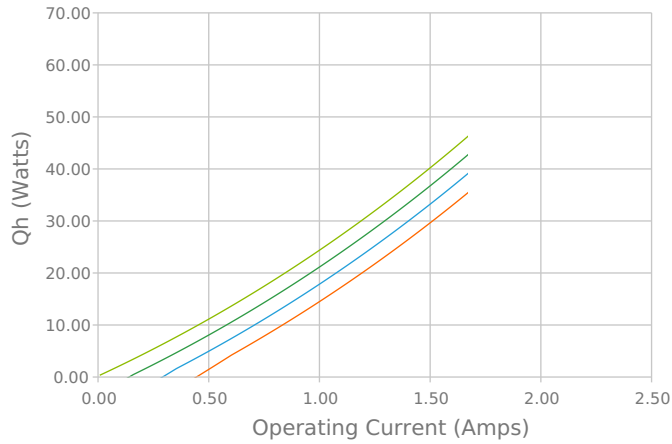

Total Heat Dissipated at Hot Side (Qh=Qc+Pin)
 Tambient = 35°C | Tcontrol = 20°C

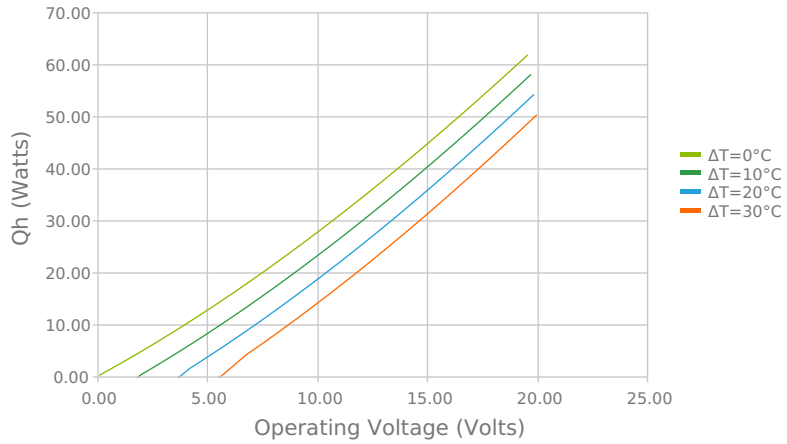

Heat Pumped at Cold Side (Qc)
 Voperating = 0 Volts | Ioperating = 0 Amps

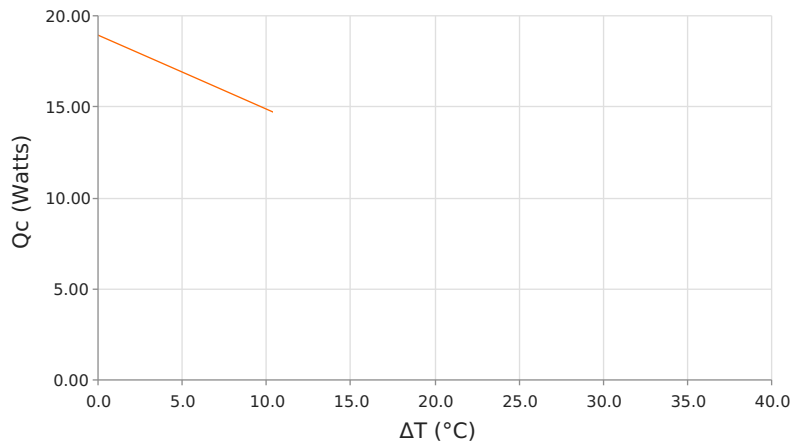

Coefficient of Performance (COP = Qc/Pin)
 Voperating = 0 Volts | Ioperating = 0 Amps

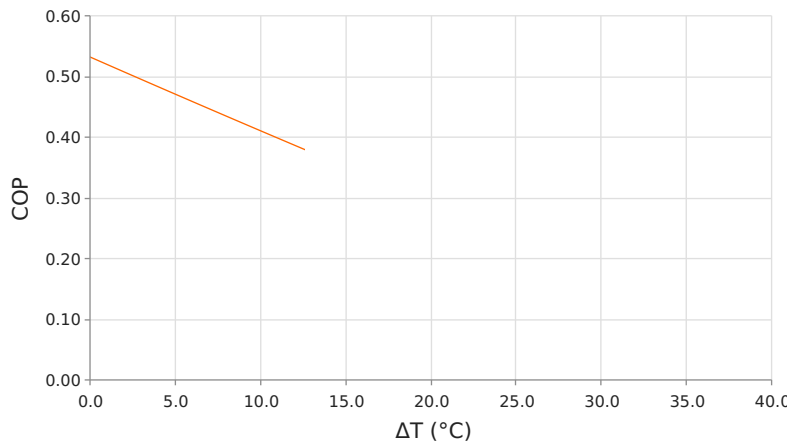

SPECIFICATIONS

Operating Temperature Range

-10 °C to 48°C

Supply Voltage

24.0 VDC nominal / 30.0 VDC maximum

Current Draw

1.4 A running / 1.7 A startup

Power Supply

34.0 Watts

Performance Tolerance

10%

Fan MTBF

50,000 hours

Weight

0.50 kg

NOTES

¹For indoor use only

²Turbulators are mounted inside liquid channels to create turbulent flow

³Cold block requires insulation to minimize moisture buildup under dew point conditions.

Any information furnished by Laird and its agents, whether in specifications, data sheets, product catalogues or otherwise, is believed to be (but is not warranted as being) accurate and reliable, is provided for information only and does not form part of any contract with Laird. All specifications are subject to change without notice. Laird assumes no responsibility and disclaims all liability for losses or damages resulting from use of or reliance on this information. All Laird products are sold subject to the Laird Terms and Conditions of sale (including Laird's limited warranty) in effect from time to time, a copy of which will be furnished upon request.

© Copyright 2020 Laird Thermal Systems GmbH. All Rights Reserved. Laird, Laird Technologies, Laird Thermal Systems, the Laird Logo, and other word marks and logos are trademarks or registered trademarks of Laird Limited or an affiliate company thereof. Other product or service names may be the property of third parties. Nothing herein provides a license under any Laird or any third party intellectual property rights.

Date: 04/24/2020