

**Ceramic Plate Series Thermoelectric Cooler**

The CP10-63-06-L1-EP-W4.5 is a high-performance and highly reliable standard Thermoelectric Cooler. Assembled with Bismuth Telluride semiconductor material and thermally conductive Aluminum Oxide ceramics. It has a maximum  $Q_c$  of 12.6 Watts when  $\Delta T = 0$  and a maximum  $\Delta T$  of 70.5 °C at  $Q_c = 0$ .

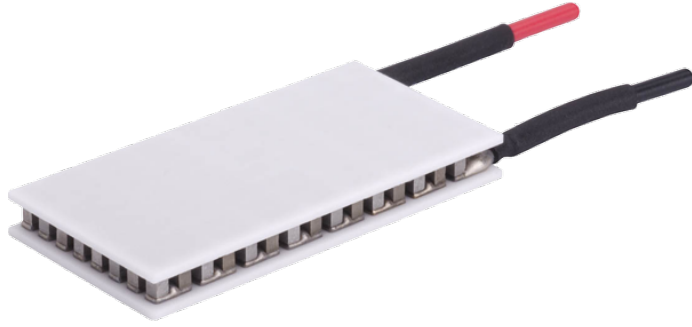

**Features**

- Compact geometric sizes
- DC Operation
- RoHS-compliant

**Applications**

- Thermoelectric Coolers for Reagent Storage
- Thermoelectric Coolers for Handheld Cosmetic Lasers
- Cooling for Centrifuges
- Heads-Up Displays, Imaging Sensors
- Peltier Cooling for Machine Vision

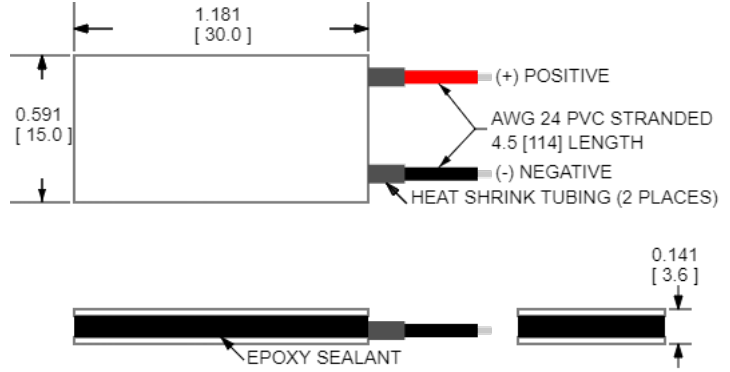

CERAMIC MATERIAL: Al<sub>2</sub>O<sub>3</sub>  
 SOLDER CONSTRUCTION: 138°C, BiSn  
 Note: Allow 0.020 in [0.5 mm] around perimeter of the thermoelectric cooler and lead wire attachment to accommodate sealant

INCHES [ MM ]

**ELECTRICAL AND THERMAL PERFORMANCE**

Heat Pumped at Cold Side  
 $T_{hot} = 27\text{ °C}$

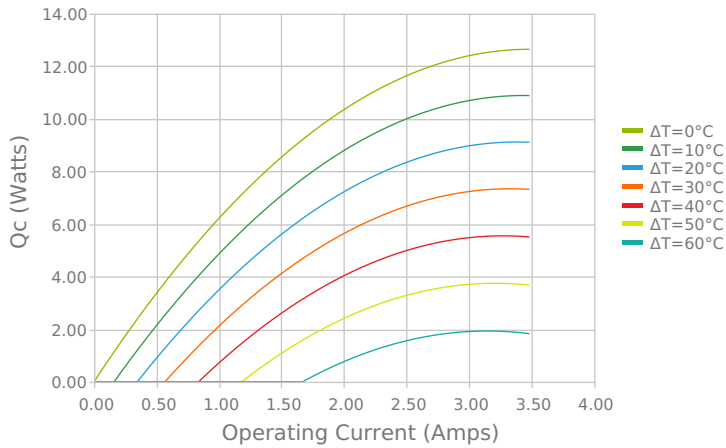

Heat Pumped at Cold Side  
 $T_{hot} = 27\text{ °C}$

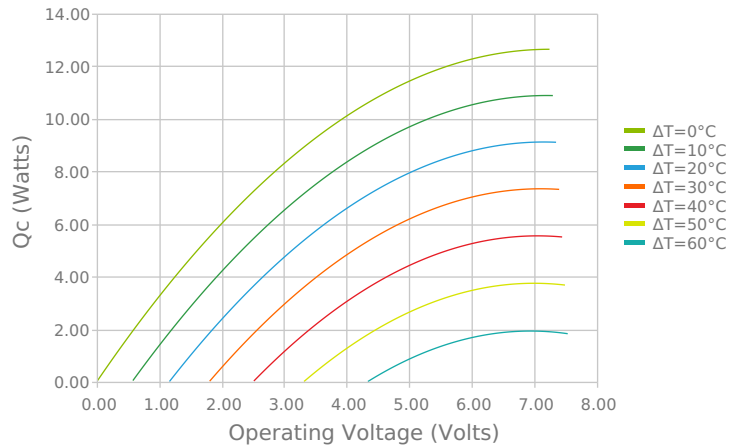

Current vs Voltage (I vs V)  
 $T_{hot} = 27\text{ °C}$

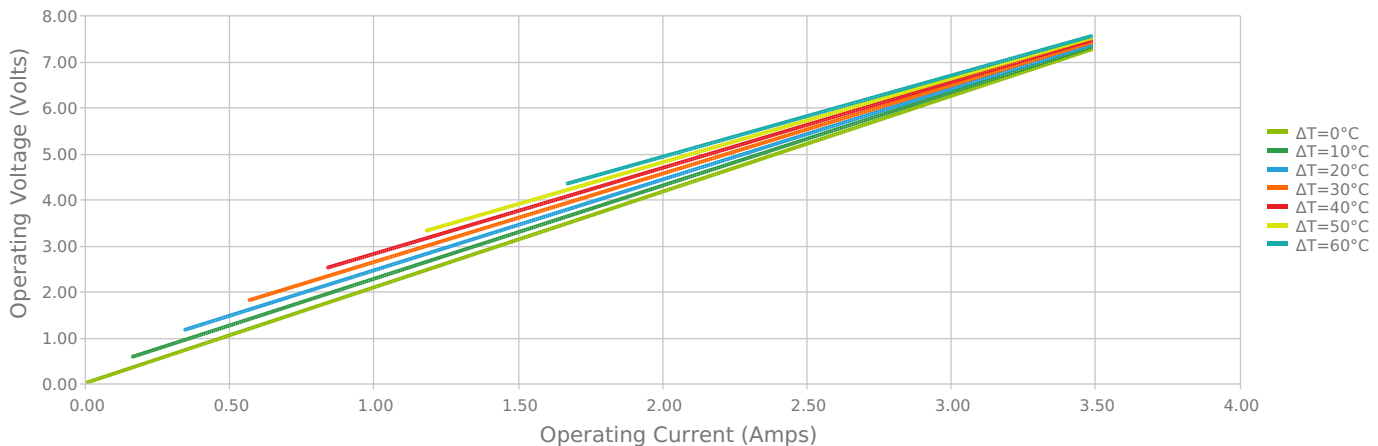

Coefficient of Performance (COP = Qc/Pin)  
 Thot = 27 °C

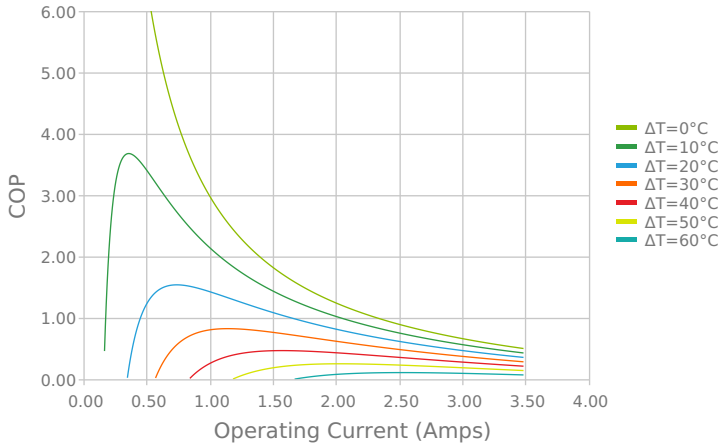

Coefficient of Performance (COP = Qc/Pin)  
 Thot = 27 °C

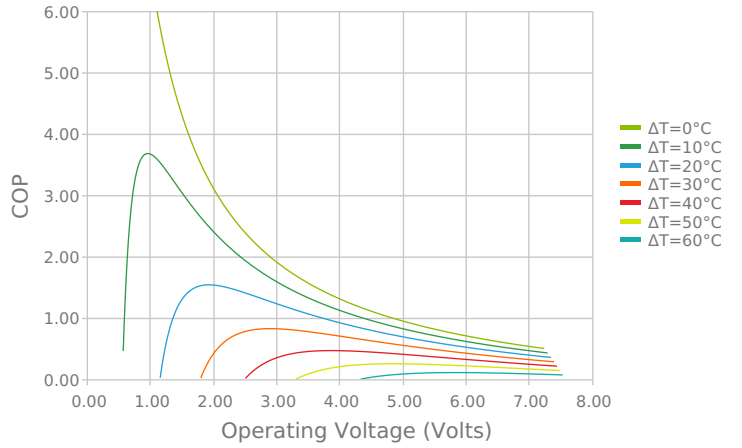

Total Heat Dissipated at Hot Side (Qh=Qc+Pin)  
 Thot = 27 °C

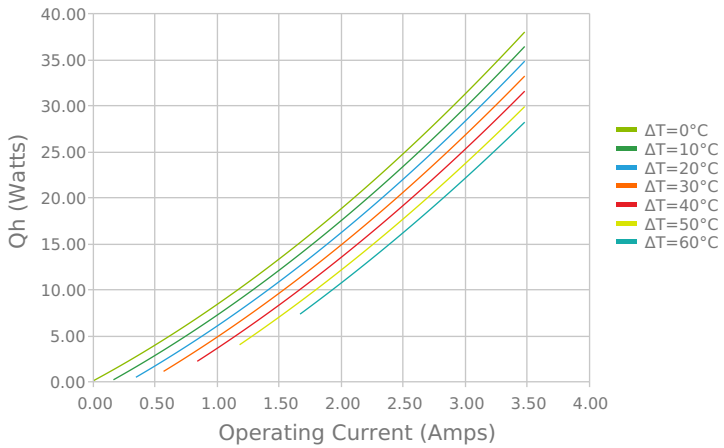

Total Heat Dissipated at Hot Side (Qh=Qc+Pin)  
 Thot = 27 °C

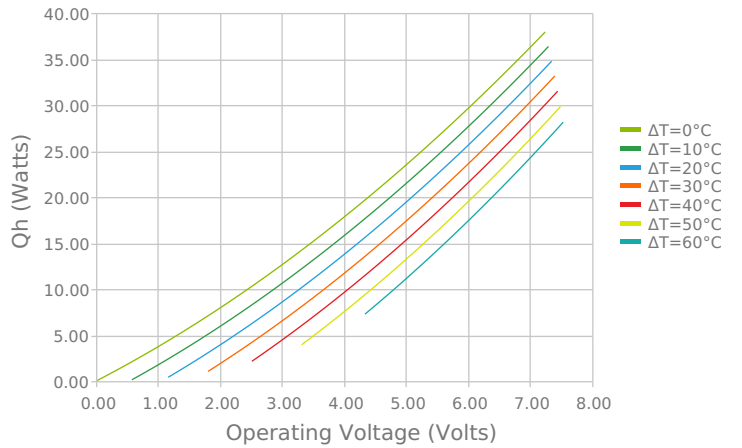

Heat Pumped at Cold Side (Qc)  
 Thot = 27 °C | Current = 2.6 Amps

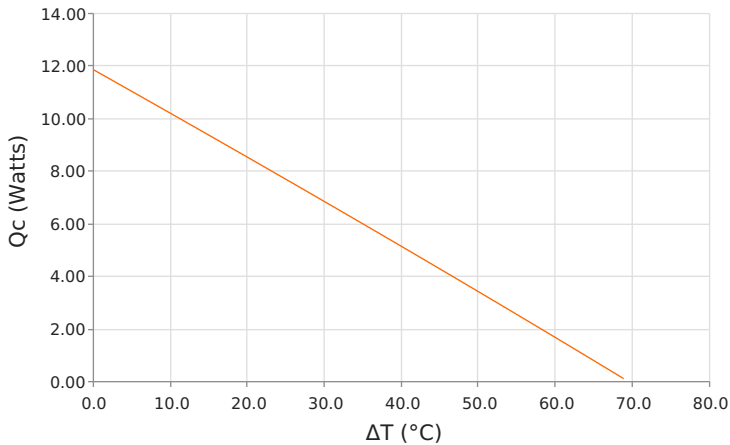

Coefficient of Performance (COP = Qc/Pin)  
 Thot = 27 °C | Current = 2.6 Amps



## SPECIFICATIONS\*

	27.0 °C	35.0 °C	50.0 °C
<b>Hot Side Temperature</b>			
<b>Qcmax (<math>\Delta T = 0</math>)</b>	12.6 Watts	13.0 Watts	13.7 Watts
<b><math>\Delta T_{max}</math> (<math>Q_c = 0</math>)</b>	70.5°C	73.5°C	78.8°C
<b>I<sub>max</sub> (I @ <math>\Delta T_{max}</math>)</b>	3.1 Amps	3.1 Amps	3.0 Amps
<b>V<sub>max</sub> (V @ <math>\Delta T_{max}</math>)</b>	6.9 Volts	7.1 Volts	7.6 Volts
<b>Module Resistance</b>	2.08 Ohms	2.17 Ohms	2.33 Ohms
<b>Max Operating Temperature</b>	80 °C		
<b>Weight</b>	6.0 gram(s)		

\* Specifications reflect thermoelectric coefficients updated March 2020

## FINISHING OPTIONS

Suffix	Thickness	Flatness / Parallelism	Hot Face	Cold Face	Lead Length
L1	3.581 ±0.025 mm 0.141 ± 0.0010 in	0.025 mm / 0.025 mm 0.001 in / 0.001 in	Lapped	Lapped	114.3 mm 4.50 in

## SEALING OPTIONS

Suffix	Sealant	Color	Temp Range	Description
EP	Epoxy	Black	-55 to 150°C	Low density syntactic foam epoxy encapsulant

## NOTES

1. Max operating temperature: 80°C
2. Do not exceed I<sub>max</sub> or V<sub>max</sub> when operating module
3. Reference assembly guidelines for recommended installation
4. Solder tinning also available on metallized ceramics

Any information furnished by Laird and its agents, whether in specifications, data sheets, product catalogues or otherwise, is believed to be (but is not warranted as being) accurate and reliable, is provided for information only and does not form part of any contract with Laird. All specifications are subject to change without notice. Laird assumes no responsibility and disclaims all liability for losses or damages resulting from use of or reliance on this information. All Laird products are sold subject to the Laird Terms and Conditions of sale (including Laird's limited warranty) in effect from time to time, a copy of which will be furnished upon request.

© Copyright 2019-2021 Laird Thermal Systems, Inc. All rights reserved. Laird™, the Laird Ring Logo, and Laird Thermal Systems™ are trademarks or registered trademarks of Laird Limited or its subsidiaries.

Date: 12/13/2021