

PowerCycling PCX Series Thermoelectric Cooler

The PCX11-191-F1-3553-TA-RT-W6 is a high-performance thermoelectric cooler designed for thermal cycling between multiple temperature set points and is ideal for applications in healthcare among others, where fast temperature changes are required. The thermoelectric module is specially constructed to reduce the amount of stress induced on the thermoelectric elements during operation. It has a maximum Qc of 147.8 Watts when $\Delta T = 0$ and a maximum ΔT of 73.6 °C at Qc = 0.

Features

- High thermal cycling reliability
- Precise temperature control
- Solid-state operation
- Boosted performance with next-gen material
- RoHS-compliant

Applications

- Molecular Diagnostics (DNA Amplification, PCR)
- Point of Care Testing Devices
- Thermal Test Sockets

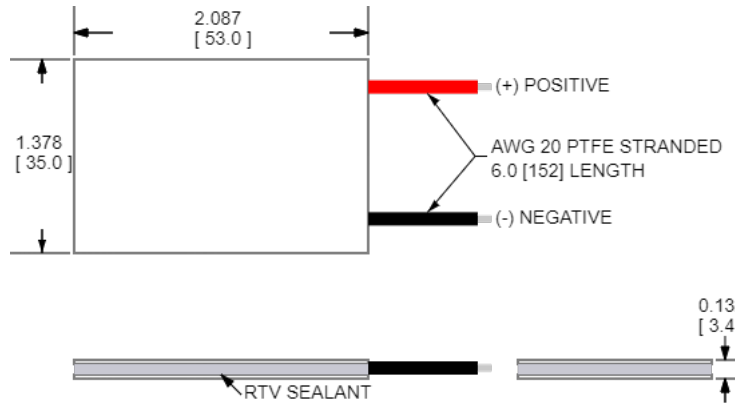

CERAMIC MATERIAL: Al₂O₃
 SOLDER CONSTRUCTION: 232°C, SbSn
 Note: Allow 0.020 in [0.5 mm] around perimeter of the thermoelectric cooler and lead wire attachment to accommodate sealant

INCHES [MM]

ELECTRICAL AND THERMAL PERFORMANCE

Heat Pumped at Cold Side
 Thot = 27 °C

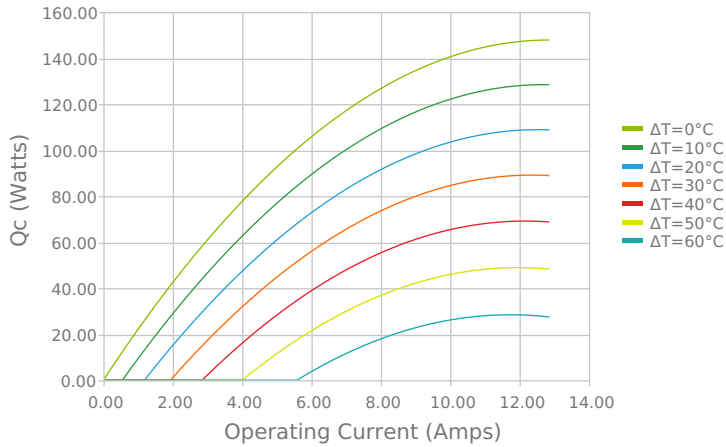

Heat Pumped at Cold Side
 Thot = 27 °C

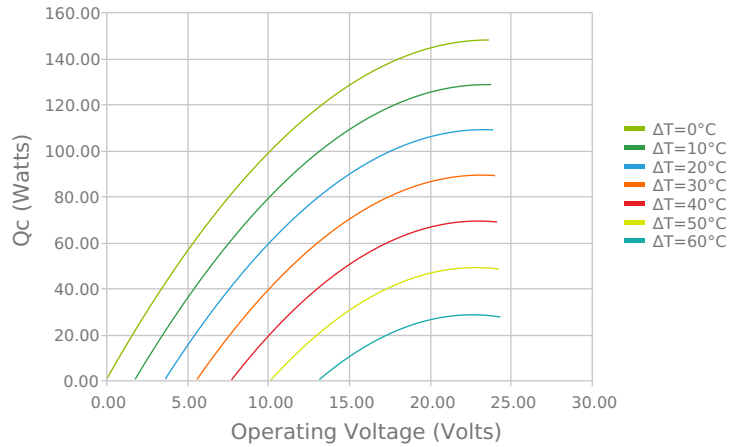

Current vs Voltage (I vs V)
 Thot = 27 °C

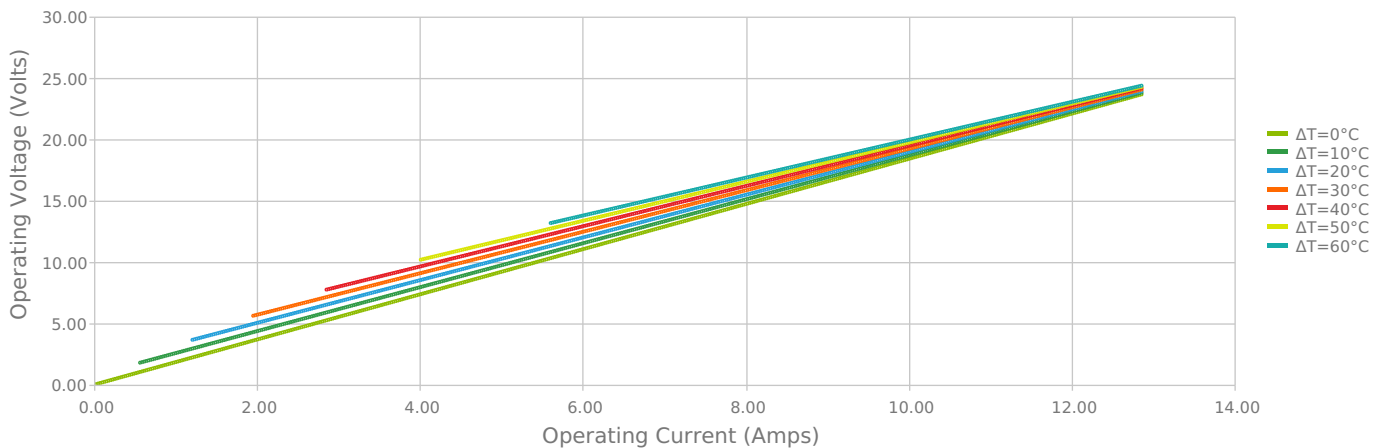

Coefficient of Performance (COP = Qc/Pin)
 Thot = 27 °C

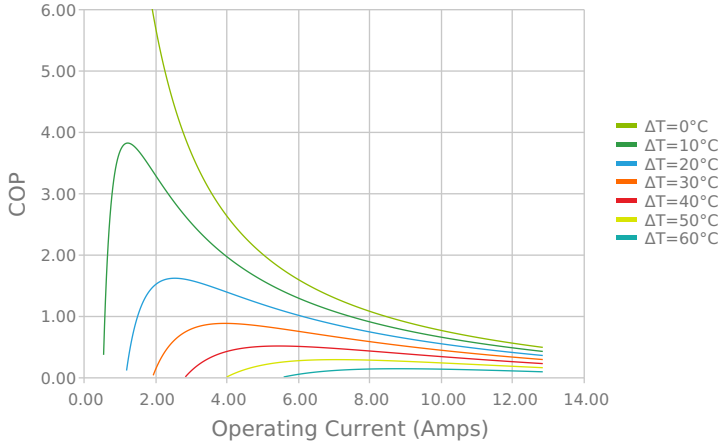

Coefficient of Performance (COP = Qc/Pin)
 Thot = 27 °C

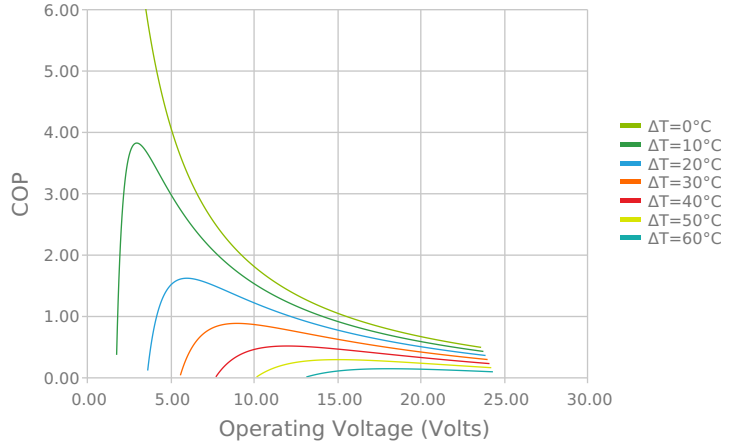

Total Heat Dissipated at Hot Side (Qh=Qc+Pin)
 Thot = 27 °C

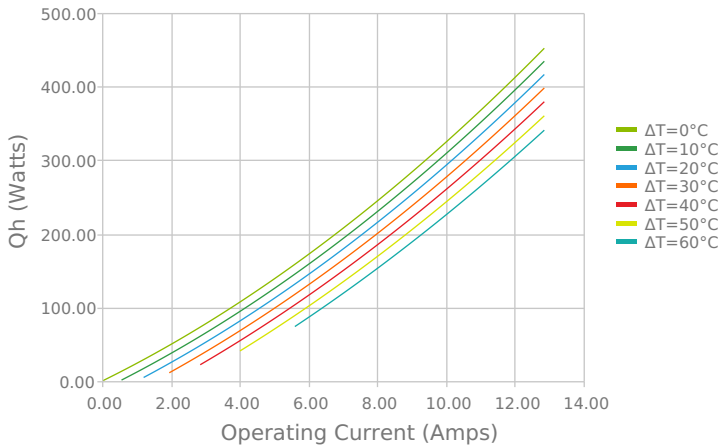

Total Heat Dissipated at Hot Side (Qh=Qc+Pin)
 Thot = 27 °C

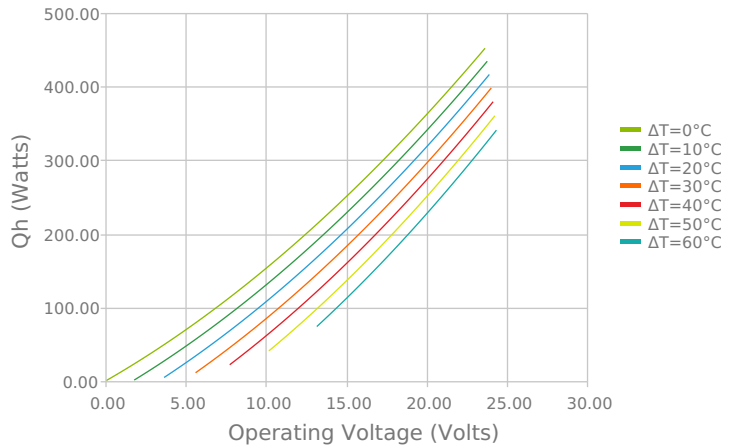

Heat Pumped at Cold Side (Qc)
 Thot = 27 °C | Current = 9.6 Amps

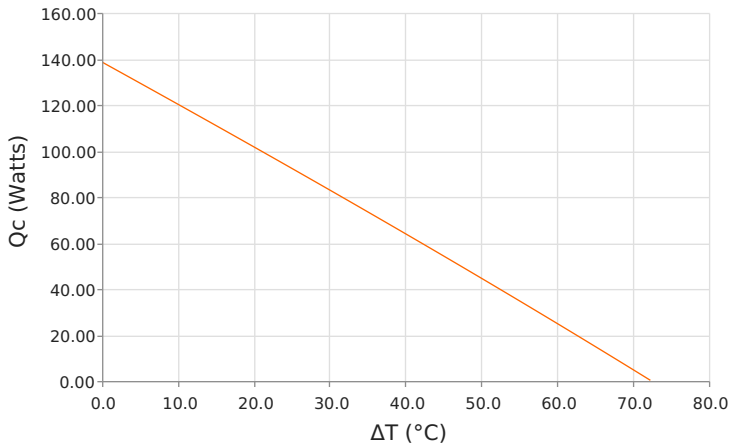

Coefficient of Performance (COP = Qc/Pin)
 Thot = 27 °C | Current = 9.6 Amps

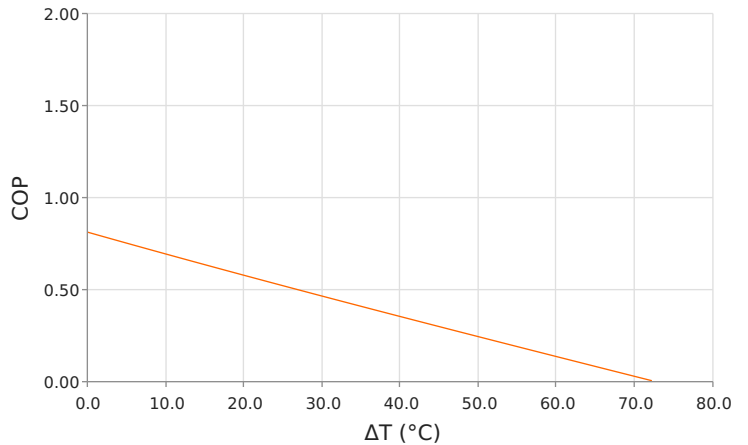

SPECIFICATIONS*

Hot Side Temperature	27.0 °C	50.0 °C	80.0 °C
Qcmax ($\Delta T = 0$)	147.8 Watts	159.1 Watts	170.6 Watts
ΔT_{max} ($Q_c = 0$)	73.6°C	82.6°C	93.1°C
I_{max} (I @ ΔT_{max})	11.4 Amps	11.2 Amps	10.8 Amps
V_{max} (V @ ΔT_{max})	22.4 Volts	24.8 Volts	28.0 Volts
Module Resistance	1.84 Ohms	2.07 Ohms	2.37 Ohms
Max Operating Temperature	120 °C		
Weight	50.0 gram(s)		

* Specifications reflect thermoelectric coefficients updated March 2020

FINISHING OPTIONS

Suffix	Thickness	Flatness / Parallelism	Hot Face	Cold Face	Lead Length
TA	3.350 ±0.025 mm 0.132 ± 0.0010 in	0.025 mm / 0.025 mm 0.001 in / 0.001 in	Lapped	Lapped	152.4 mm 6.00 in

SEALING OPTIONS

Suffix	Sealant	Color	Temp Range	Description
RT	RTV	Translucent or White	-60 to 204°C	Non-corrosive, silicone adhesive

NOTES

1. Max operating temperature: 120°C
2. Do not exceed I_{max} or V_{max} when operating module
3. Reference assembly guidelines for recommended installation
4. Solder tinning also available on metallized ceramics

Any information furnished by Laird and its agents, whether in specifications, data sheets, product catalogues or otherwise, is believed to be (but is not warranted as being) accurate and reliable, is provided for information only and does not form part of any contract with Laird. All specifications are subject to change without notice. Laird assumes no responsibility and disclaims all liability for losses or damages resulting from use of or reliance on this information. All Laird products are sold subject to the Laird Terms and Conditions of sale (including Laird's limited warranty) in effect from time to time, a copy of which will be furnished upon request.

© Copyright 2019-2021 Laird Thermal Systems, Inc. All rights reserved. Laird™, the Laird Ring Logo, and Laird Thermal Systems™ are trademarks or registered trademarks of Laird Limited or its subsidiaries.

Date: 08/24/2021